

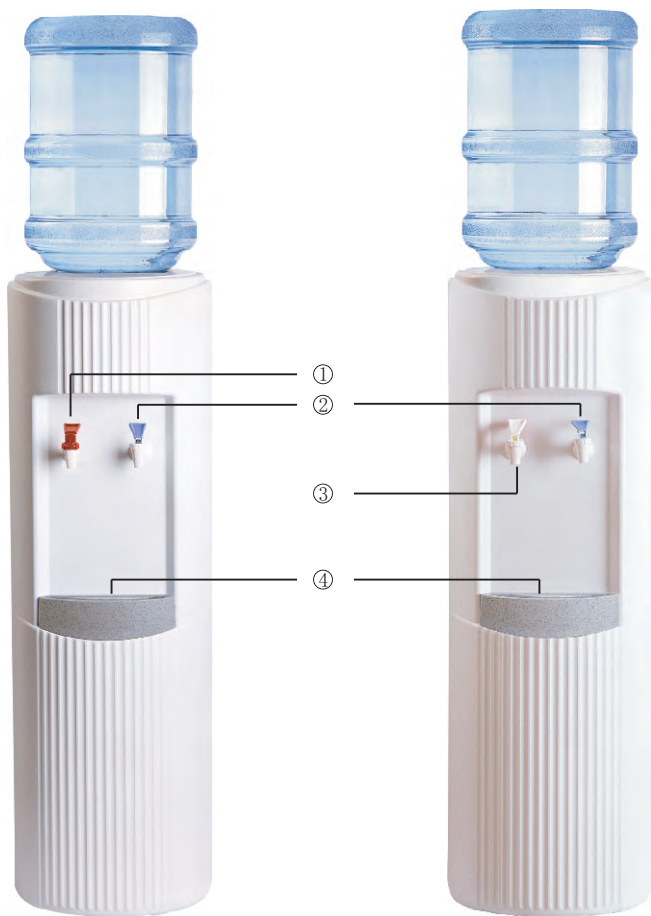

GLACIER

Bottled Water Dispenser User Manual



- 1、 Hot Water Faucet (with Child Safety Feature)
- 2、 Cold Water Faucet
- 3、 Cook Water Faucet (Room Temperature Water)
- 4、 Drip Tray

■ Parts may not appear exactly as shown

THANK YOU FOR BUYING A CRYSTAL MOUNTAIN WATER COOLER!

RECEIVING

Inspect the cooler box immediately and carefully for any evidence of shipping or handling damage before signing to receive goods. In case of shipping damage, claims should be filed immediately with the carrier. Please note that the carrier will not accept claims for any damage discovered after the signing for UNINSPECTED GOODS. Ensure cooler stands upright for 24 hours before plugging it in.

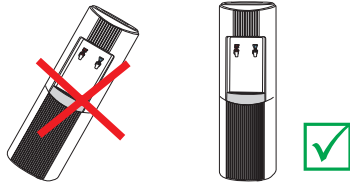

OPERATION

1. Place the water cooler on a flat level surface in a cool shaded location near a grounded wall outlet. Position water dispenser so that the back of the unit is a minimum of 2 inches / 5cm away from the wall to ensure proper ventilation.(Figure 1)
2. Place the water bottle on top of the cooler appropriately. For open reservoir models, the bottle cap needs to be removed.(Figure 2)

Note: On H&C models, vent the hot tank by holding the red faucet open until water flows out. (Heater switch (Figure 3) may now be turned on)

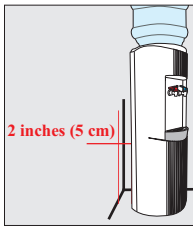

Figure 1

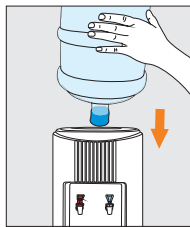

Figure 2

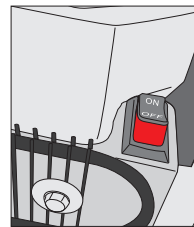

Figure 3

3. Ensure that the available power supply matches the cooler's voltage specifications indicated on the nameplate label (located at the rear of unit). Plug power supply cord into receptacle (Figure 4).Please ensure that cooler is set up so as access to the power outlet and plug is unobstructed.

Note: To provide additional protection from the risk of shock, this unit **MUST** be connected to a ground fault circuit interrupter (GFCI) outlet at all times. Use of an extension cord will void any warranties.

4. Do not draw water from the cooler for about 30 minutes to let the water cool or heat. Optimum water temperatures will be reached after several hours of operation. (Figure 5 and Figure 6)

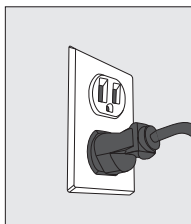

Figure 4

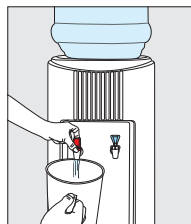

Figure 5

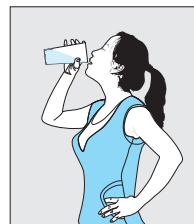

Figure 6

5. Ensure the following when cooler is to be serviced:

5.1 Turn off Hot Tank Switch (Hot & Cold models only) and disconnect power supply cord. (Figure 7 and Figure 8)

5.2 Remove bottle from reservoir. (Figure 9)

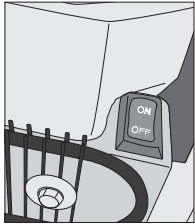

Figure 7

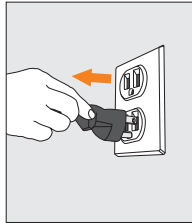

Figure 8

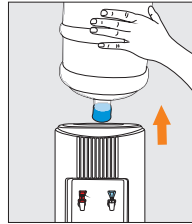

Figure 9

5.3 Use a bucket to drain water from the cold water reservoir through faucets. On Hot & Cold models (Figure 10), turn off hot tank switch as above (Figure 11). Allow 1 hour for the hot water to cool down inside the hot water tank. Remove the drain plug at the rear of the cooler to drain into a container. (Figure 12 and Figure 13)

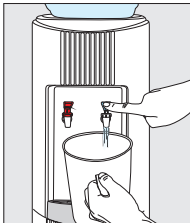

Figure 10

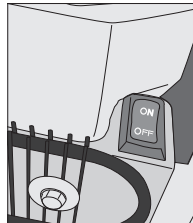

Figure 11

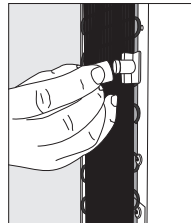

Figure 12

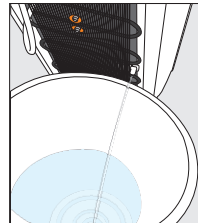

Figure 13

CAUTION! ALWAYS DRAIN WATER COMPLETELY BEFORE SHIPPING OR STORING THE COOLER!

REMOVABLE RESERVOIR

E&S Series

On Cook & Cold and Hot & Cold models the reservoir can be removed easily by following the steps given below.

1. Unplug (Figure 14) and approach the cooler from the front.
2. Remove the water bottle (Figure 15) and drain water from the reservoir and hot tank, remembering to cool and drain hot tank. Allow 1 hour for hot water to cool down inside the hot tank before removing the drain plug at the rear of the cooler to drain into a bucket (Figure 16 and Figure 17).

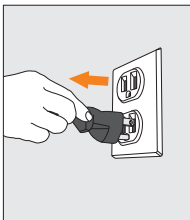

Figure 14



Figure 15

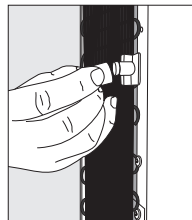

Figure 16

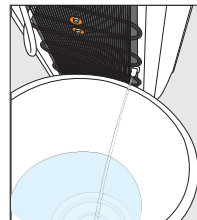

Figure 17

3. Remove the locking pin from the Crystal Guard (Figure 18), which may be stiff, requiring a tool. Use the fingertips of both hands to press on the Crystal Guard and turn counter clockwise till it is free from the cooler opening (Figure 19 and Figure 20).

Note: If the cooler is equipped with a DryGuard™, see the DryGuard™ removal section of the instructions.

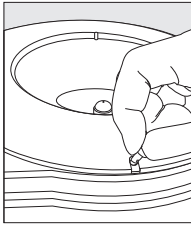

Figure 18

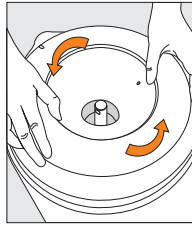

Figure 19

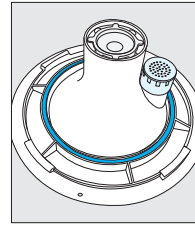

Figure 20

4. Use fingers of both hands to lift up and remove the insulation jacket covering the reservoir, from the cooler opening (Figure 21 and Figure 22).

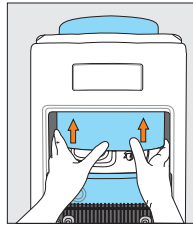

Figure 21

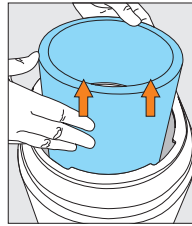

Figure 22

5. Remove the baffle cup by lifting straight out (Figure 23). Loosen & remove the baffle stem and wing nut by turning counterclockwise. (Figure 24 and Figure 25)



Figure 23

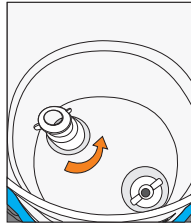

Figure 24

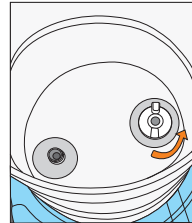

Figure 25

6. Approach the cooler from the rear and open the latch provided on the evaporator band (Figure 26).

7. Use both hands to loosen the reservoir from the evaporator band and lift it straight through the cooler opening (Figure 27).

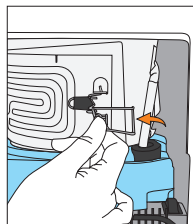

Figure 26

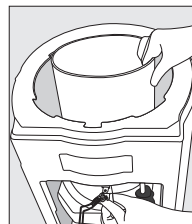

Figure 27

R, P, & G Series

On Cook & Cold and Hot & Cold models the reservoir can be removed easily by following the steps given below.

1. Unplug (Figure 28) and approach the cooler from the front.
2. Remove the water bottle (Figure 29) and drain water from the reservoir and hot tank, remembering to cool and drain hot tank. Allow 1 hour for hot water to cool down inside the hot tank before removing the drain plug at the rear of the cooler to drain into a bucket (Figure 30 and Figure 31).

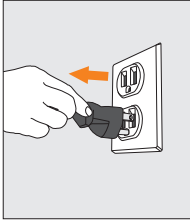

Figure 28



Figure 29

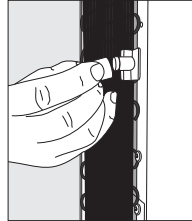

Figure 30

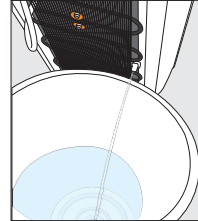

Figure 31

3. Remove the locking pin from the Crystal Guard (Figure 32), which may be stiff, requiring a tool. Use the fingertips of both hands to press on the Crystal Guard and turn counter clockwise till it is free from the cooler opening (Figure 33)

Note: If the cooler is equipped with the DryGuard™, see the DryGuard™ removal section of the instructions.

4. Using fingers of both hands loosen and remove the insulation jacket covering the plastic reservoir from the cooler opening (Figure 34). (Note: On Hot & Cold models, after step 4 unscrew the round plastic one piece baffle (Figure 35))

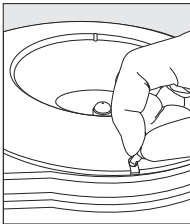

Figure 32

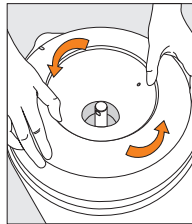

Figure 33

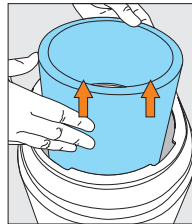

Figure 34

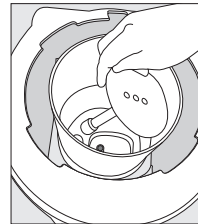

Figure 35

5. Approach the cooler from the rear and open the latch provided on the evaporator band. (Figure 36)
6. Remove the faucets from the reservoir elbows by turning them counter clockwise. (Figure 37)
7. Using both hands, loosen the reservoir from the evaporator band and lift it straight through the cooler opening (Figure 38).

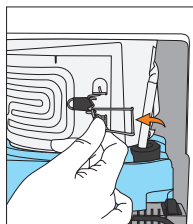

Figure 36

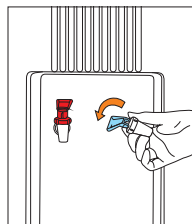

Figure 37

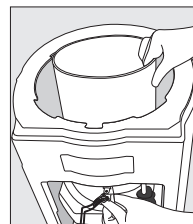

Figure 38

DryGuard™

Installation (See Figure 49)

1. Place the Inner DryGuard™ Cone assembly onto the center of the cold water reservoir; make sure the words "LIFT THIS SIDE TO REMOVE" is aligned with the sides of the cooler and that the filter cap is positioned towards the rear of the cooler (Figure 39).
2. Using the palms of both hands, push the DryGuard™ straight down into the reservoir (Figure 40).
3. Install the Outer DryGuard™ Cover onto the cooler in the proper position on the body and lock into place by turning clockwise until it fits tightly (Figure 41 and Figure 42).

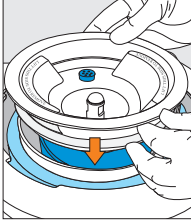

Figure 39

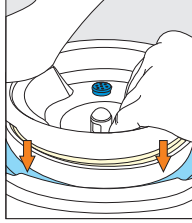

Figure 40

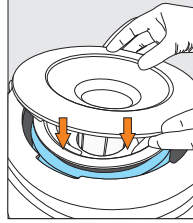

Figure 41

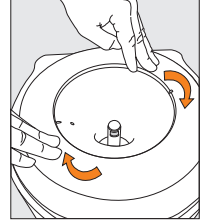

Figure 42

Removal (See Figure 49)

1. Remove the bottle from the cooler (Figure 43).
2. Loosen and remove the Outer DryGuard™ Cover from cooler's body by pressing the fingertips of both hands onto lid and turning it counter clockwise until it is free from the cooler opening (Figure 44 and Figure 45).
3. Approaching the cooler from left (or right), Place one palm onto the top of the cooler on the side furthest from you, and using your thumb, press downwards on the reservoir Insulation. Using your other hand, grip the edge of the Inner DryGuard™ Cone and pull it up slowly to remove (Figure 46).

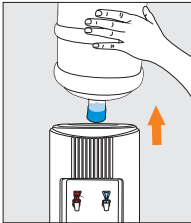

Figure 43

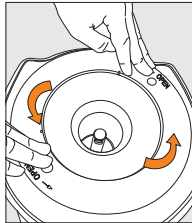

Figure 44

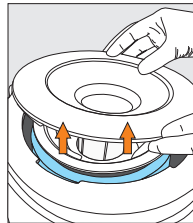

Figure 45

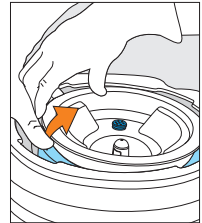

Figure 46

CLEANING

Do Not Immerse the Unit in Water for Cleaning

Remove any dust or contaminants from the cooler by rinsing the cold water reservoir and faucets with clean water prior to use (Figure 47 and Figure 48). Use only mild dishwashing liquid detergent for cleaning the exterior surfaces. **DO NOT USE** bleach or abrasive cleaners.

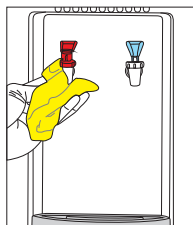

Figure 47

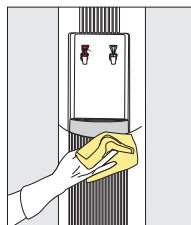

Figure 48

Outer DryGuard™ Cover Removal and Installation

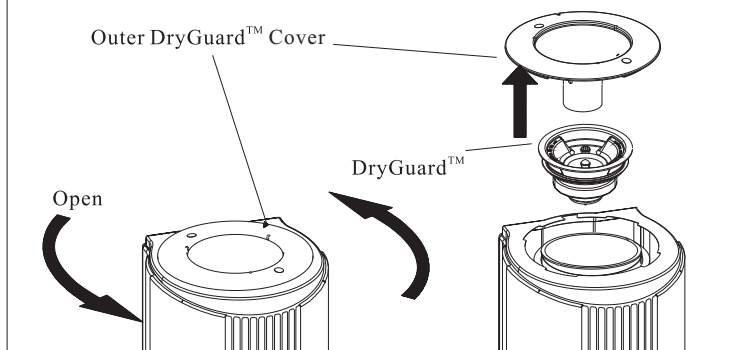

Figure 49

Note: The product you have purchased may look different than the model shown in (Figure 50).

Crystal Guard Removal and Installation

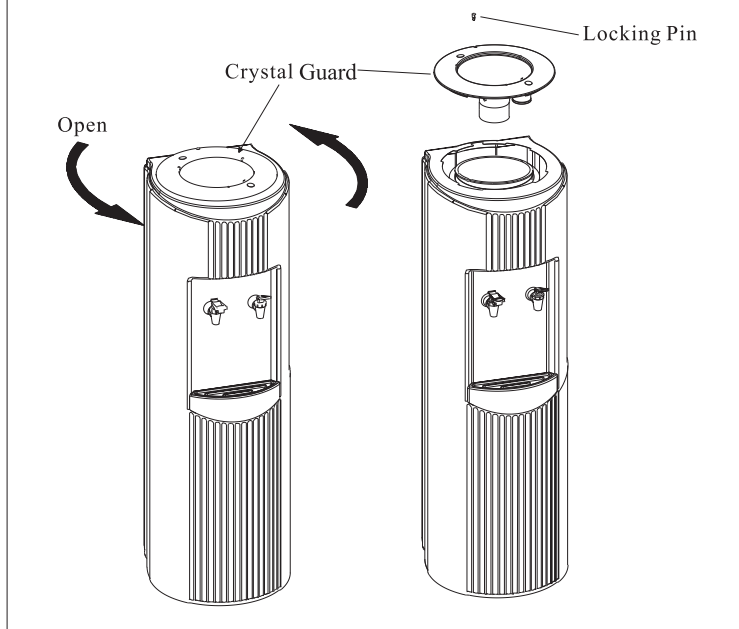

Figure 50

Standup Series Bracket Installation Instructions

INSTALLATION

1. Remove the two mounting screws that secure the Bottom Plate to the outer enclosure.
2. While holding the "S" shaped bracket against the cooler (refer to diagram) reinstall and tighten the bottom plate/outer enclosure screws securely.
3. Place the cooler in position against the wall and using the "S" bracket, mark the location of the wall insert holes to be drilled (if required). If not required, secure the cooler to the wall using the two screws provided.

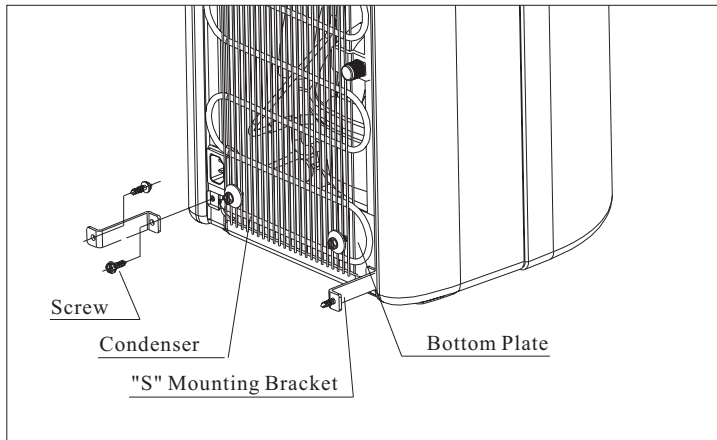

Figure 51

WARNING:

The warranty and Underwriters' Laboratory and CE listings for the coolers are invalidated if any alteration, modification, or use or misuse in combination with any other machine or devices is deemed to be the source of any claim. The manufacturer accepts no liability (including for bodily injury) resulting from any alteration, misuse, neglect, accidents, improper installations or repairs.

The Red Faucet dispenses hot water during normal operation that may cause severe burns.

This appliance is not intended for use by persons (including children) with reduced physical, sensory or mental capabilities, or lack of experience and knowledge, unless they have been given supervision or instruction concerning use of the appliance by a person responsible for their safety.

Children should be supervised to ensure that they do not play with the appliance.

If the supply cord is damaged, it must be replaced by a special cord or assembly available from the manufacturer or its service agent.



This marking indicates that this product should not be disposed with other household wastes throughout the EU. To prevent possible harm to the environment or human health from uncontrolled waste disposal, recycle it responsibly to promote the sustainable reuse of sustainable resources. To return your used device, please use the return and collection systems or contact the retailer where the product was purchased. They can take this product for environmental safe recycling.

The customer acknowledges that water, like other liquids, can cause damage to surfaces. The customer takes full responsibility for placing the cooler within a residence or business, and acknowledges that failure to address drips, leaks or spillages is at the customer's risk.

Environmental application temperature: 10~32°C.

The unit is rated IP10. (This unit is not protected against ingress of water)

For more information on this product, please visit www.crystalcoolers.com